



**SUPERLIGHT HLP3116 LED MOUNTING PROFILE WITH OPAL DIFFUSER**

SUPERLIGHT HLP3116 is a popular profile for use in residential lighting applications. Can be used for general purpose lighting, joinery lighting and is an excellent general mounting accessory for any LED striplighting project.

**Profile Dimensions**  
26.6x15mm

**Standard Profile Length**  
Custom lengths as required

**Installation Options**  
Surface Mounted  
Trimless / Recessed

**Optional Accessories**  
End Cap Kit  
Metal Fixing Clips

**Lens/Diffuser**  
Opal polycarbonate diffuser insert

**Available Finishes**  
Anodised Silver  
Dulux Powdercoat  
Custom Anodised Finish by Request

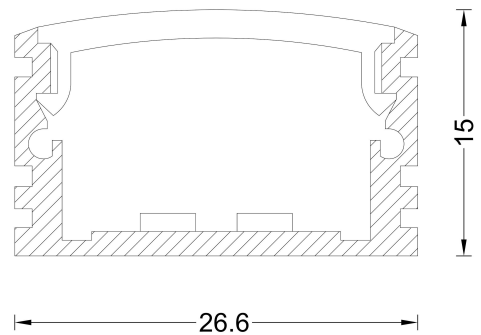

Customised Profiles can be designed and made to order on a bespoke basis. Contact our representative for more information. Please re-confirm product details prior to ordering. Actual specifications ordered may vary. [www.superlight.com.au](http://www.superlight.com.au) [www.superlight.co.nz](http://www.superlight.co.nz)

**SUPERLIGHT**